











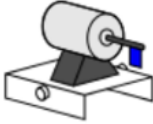

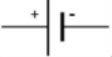





PB-C2-CONTRÔLE-SUJET A-CORRECTION

Exercice 1 : Rappels de cours

				
Pile	Lampe	Moteur	Diode	Fil électrique
				
				
Générateur	DEL	Résistance	Interrupteur fermé	Interrupteur ouvert
				

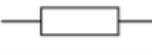
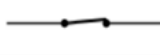
Exercice 2 : Représentation d'un circuit électrique

1-

Circuit 1

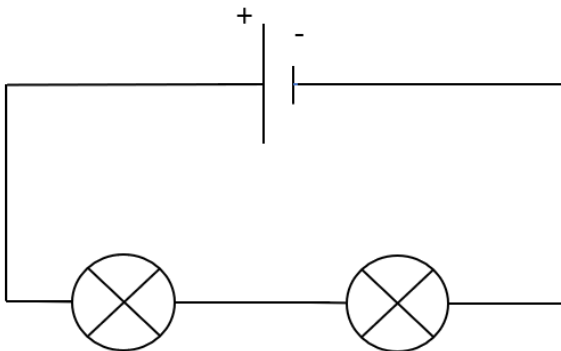

Circuit 2

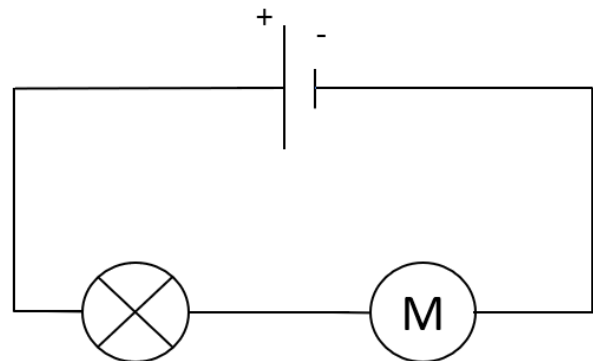

Circuit 3

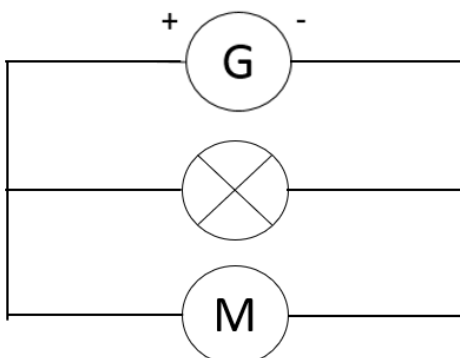

Circuit 4

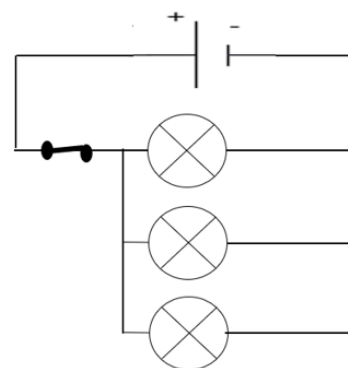

2-Les circuits en série sont les circuits 1 et 2.